



VOLTAGE RANGE: 50 ---400V

VFORWARD CURRENT: 1.0 A

DO - 213AB



Features

- * Fast switching
- * Glass passivated device
- * Ideal for surface mounted applications
- * Low leakage current
- * Metallurgically bonded construction
- * Mounting position: Any
- * Weight: 0.015 gram

Mechanical Data

- * Epoxy : Device has UL flammability classification 94V-0

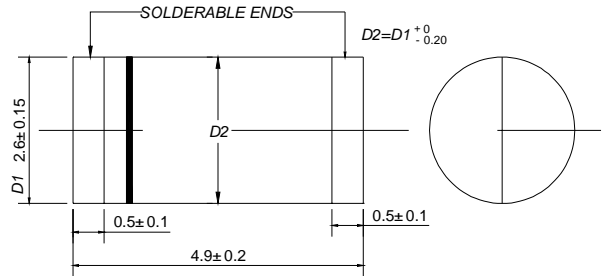

Dimensions in millimeters

MAXIMUM RATINGS AND ELECTRICAL CHARACTERISTICS

Ratings at 25 °C ambient temperature unless otherwise specified.

Single phase, half wave, 60 Hz, resistive or inductive load.

For capacitive load, derate current by 20%.

MAXIMUM RATINGS (At TA = 25°C unless otherwise noted)

RATINGS	SYMBOL	ESM101	ESM102	ESM103	ESM104	ESM105	ESM106	UNITS
Maximum Recurrent Peak Reverse Voltage	VRRM	50	100	150	200	300	400	Volts
Maximum RMS Volts	VRMS	35	70	105	140	210	280	Volts
Maximum DC Blocking Voltage	Vdc	50	100	150	200	300	400	Volts
Maximum Average Forward Current at TA = 55°C	Io	1.0						Amps
Peak Forward Surge Current, IFM (surge): 8.3 ms single half sine-wave superimposed on rated load (JEDEC method)	IFSM	30						Amps
Typical Junction Capacitance (Note 2)	CJ	15				10		pF
Operating and Storage Temperature Range	TJ, TSTG	-65 to + 175						°C

ELECTRICAL CHARACTERISTICS (At TA = 25°C unless otherwise noted)

CHARACTERISTICS	SYMBOL	ESM101	ESM102	ESM103	ESM104	ESM105	ESM106	UNITS
Maximum Forward Voltage at 1.0A DC	VF	0.95				1.25		Volts
Maximum DC Reverse Current at Rated DC Blocking Voltage	@ TA = 25°C	5.0						uAmps
	@ TA = 125°C	100						
Maximum Reverse Recovery Time (Note 1)	ttr	35						nSec

NOTES : 1. Test Conditions: IF=0.5A, IR=-1.0A, IRR=-0.25A.

2. Measured at 1 MHz and applied reverse voltage of 4.0 volts.



RATING AND CHARACTERISTIC CURVES (ESM101 THRU ESM106)

FIG. 1 - TEST CIRCUIT DIAGRAM AND REVERSE RECOVERY TIME CHARACTERISTIC

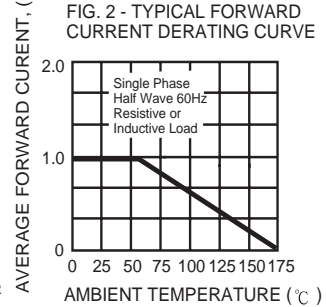
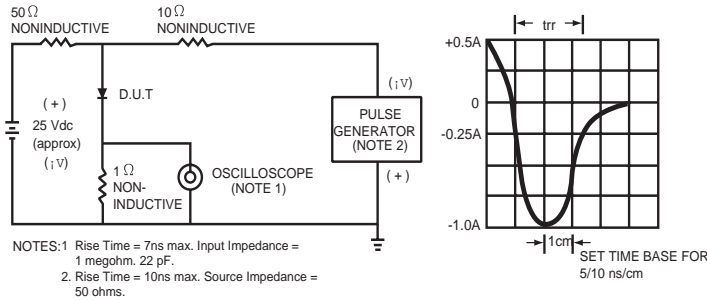

FIG. 3 - TYPICAL REVERSE CHARACTERISTICS

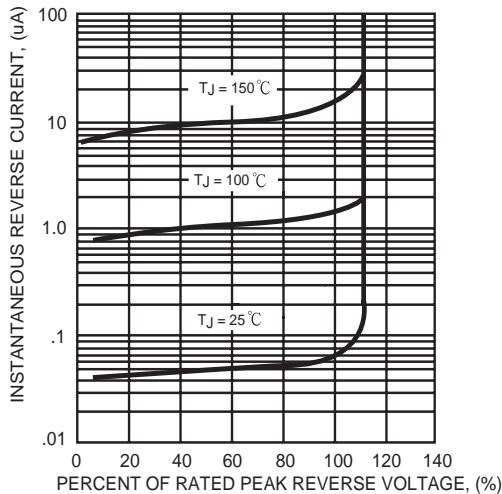

FIG. 4 - TYPICAL INSTANTANEOUS FORWARD CHARACTERISTICS

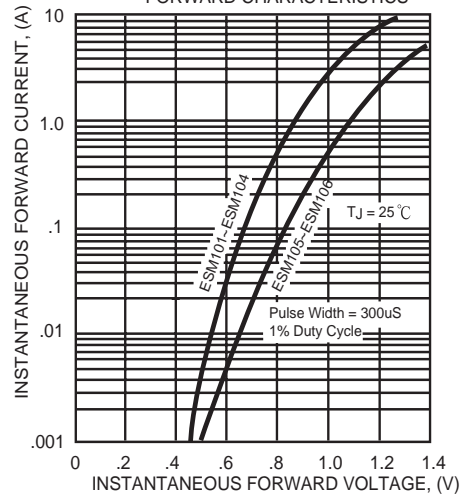

FIG. 5 - MAXIMUM NON-REPETITIVE FORWARD SURGE CURRENT

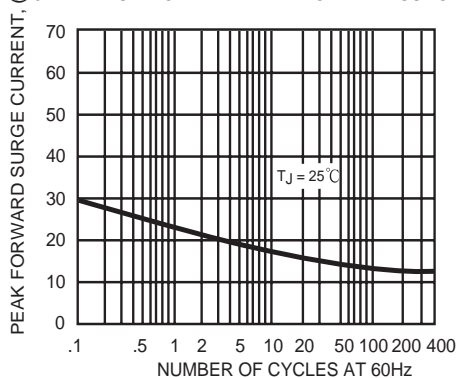
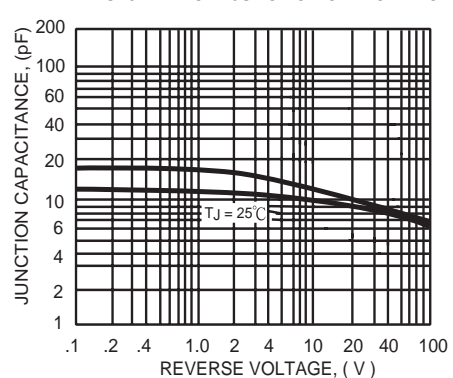

FIG. 6 - TYPICAL JUNCTION CAPACITANCE



PACKAGE	SPQ/PCS	CARTON SPQ/PCS	CARTON SIZE/CM	CARTON GW/KG	CARTON NW/KG
DO-213AB	5000/REEL	80000	36.0X35.8X36.5	18.00	16.00