

Reverse Voltage: 5.0 to 58 V
Peak Pulse Power: 600 W

Features

- Glass passivated chip
- 600 W peak pulse power capability with a 10/1000 μ s waveform, repetitive rate (duty cycle):0.01 %
- Low leakage
- Uni and Bidirectional unit
- Excellent clamping capability
- Very fast response time
- RoHS compliant

Mechanical Data

- Case: Molded plastic
- Epoxy: UL 94V-0 rate flame retardant
- Lead: Solderable per MIL-STD-750, method 2026
- Polarity: Color band denotes cathode end except Bipolar
- Mounting position: Any

SMA/ DO-214AC

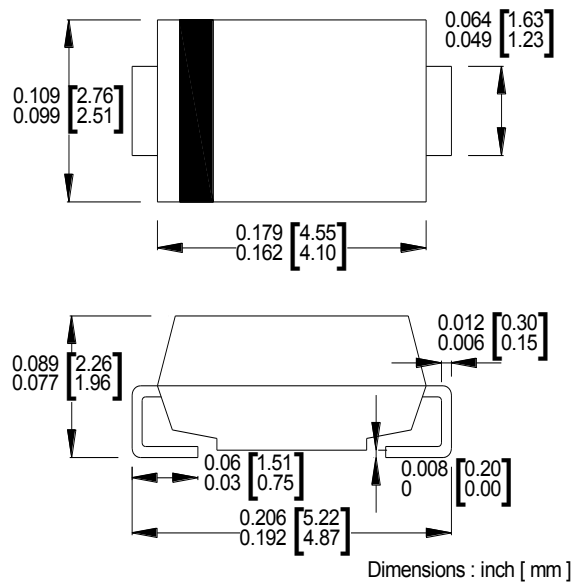

Maximum Ratings($T_A=25^\circ\text{C}$ unless otherwise noted)

Parameter	Symbol	Value	UNIT
Peak power dissipation with a 10/1000 μ s waveform ⁽¹⁾	P_{PP}	600	W
Peak pulse current with a 10/1000 μ s waveform ⁽¹⁾	I_{PP}	See Next Table	A
Power dissipation on infinite heatsink at $T_L = 75^\circ\text{C}$	P_D	3.0	W
Peak forward surge current, 8.3 ms single half sine-wave unidirectional only ⁽²⁾	I_{FSM}	60	A
Maximum instantaneous forward voltage at 25 A for unidirectional only ⁽³⁾	V_F	3.5	V
Operating junction and storage temperature range	T_J, T_{STG}	-55 to +150	$^\circ\text{C}$

Note:

(1)Non-repetitive current pulse per Fig.5 and derated above $T_A = 25^\circ\text{C}$ per Fig.1

(2)Measured on 8.3 ms single half sine-wave or equivalent square wave, duty cycle = 4 pulses per minute maximum



Electrical Characteristics ($T_A=25^{\circ}\text{C}$ unless otherwise noted)

Part Number (Uni)	Part Number (Bi)	Device Marking Code		Breakdown Voltage V_{BR} @ I_T			Maximum Reverse Leakage I_R @ V_{RWM} (μA)	Working Peak Reverse Voltage V_{RWM} (V)	Maximum Reverse Surge Current I_{PP} (A)	Maximum Clamping Voltage V_C @ I_{PP} (V)
		Uni	Bi	Min (V)	Max (V)	I_T (mA)				
SMA6J5.0A		KE		6.40	7.00	10	800	5.0	65.2	9.2
SMA6J6.0A	SMA6J6.0CA	KG	AG	6.67	7.37	10	800	6.0	58.3	10.3
SMA6J6.5A	SMA6J6.5CA	KK	AK	7.22	7.98	10	500	6.5	53.6	11.2
SMA6J7.0A	SMA6J7.0CA	KM	AM	7.78	8.60	10	200	7.0	50.0	12.0
SMA6J7.5A	SMA6J7.5CA	KP	AP	8.33	9.21	1	100	7.5	46.5	12.9
SMA6J8.0A	SMA6J8.0CA	KR	AR	8.89	9.83	1	50	8.0	44.1	13.6
SMA6J8.5A	SMA6J8.5CA	KT	AT	9.44	10.40	1	10	8.5	41.7	14.4
SMA6J9.0A	SMA6J9.0CA	KV	AV	10.00	11.10	1	5.0	9.0	39.0	15.4
SMA6J10A	SMA6J10CA	KX	AX	11.10	12.30	1	1.0	10.0	35.3	17.0
SMA6J11A	SMA6J11CA	KZ	AZ	12.20	13.50	1	1.0	11.0	33.0	18.2
SMA6J12A	SMA6J12CA	LE	BE	13.30	14.70	1	1.0	12.0	30.2	19.9
SMA6J13A	SMA6J13CA	LG	BG	14.40	15.90	1	1.0	13.0	27.9	21.5
SMA6J14A	SMA6J14CA	LK	BK	15.60	17.20	1	1.0	14.0	25.9	23.2
SMA6J15A	SMA6J15CA	LM	BM	16.70	18.50	1	1.0	15.0	24.6	24.4
SMA6J16A	SMA6J16CA	LP	BP	17.80	19.70	1	1.0	16.0	23.1	26.0
SMA6J17A	SMA6J17CA	LR	BR	18.90	20.90	1	1.0	17.0	21.7	27.6
SMA6J18A	SMA6J18CA	LT	BT	20.00	22.10	1	1.0	18.0	20.5	29.2
SMA6J19A	SMA6J19CA	LB	BB	21.10	23.30	1	1.0	19.0	19.5	30.8
SMA6J20A	SMA6J20CA	LV	BV	22.20	24.50	1	1.0	20.0	18.5	32.4
SMA6J22A	SMA6J22CA	LX	BX	24.40	26.90	1	1.0	22.0	16.9	35.5
SMA6J24A	SMA6J24CA	LZ	BZ	26.70	29.50	1	1.0	24.0	15.4	38.9
SMA6J26A	SMA6J26CA	ME	CE	28.90	31.90	1	1.0	26.0	14.3	42.1
SMA6J28A	SMA6J28CA	MG	CG	31.10	34.40	1	1.0	28.0	13.2	45.4
SMA6J30A	SMA6J30CA	MK	CK	33.30	36.80	1	1.0	30.0	12.4	48.4
SMA6J33A	SMA6J33CA	MM	CM	36.70	40.60	1	1.0	33.0	11.3	53.3
SMA6J36A	SMA6J36CA	MP	CP	40.00	44.20	1	1.0	36.0	10.3	58.1
SMA6J40A	SMA6J40CA	MR	CR	44.40	49.10	1	1.0	40.0	9.30	64.5
SMA6J43A	SMA6J43CA	MT	CT	47.80	52.80	1	1.0	43.0	8.65	69.4
SMA6J45A	SMA6J45CA	MV	CV	50.00	55.30	1	1.0	45.0	8.25	72.7
SMA6J48A	SMA6J48CA	MX	CX	53.30	58.90	1	1.0	48.0	7.75	77.4
SMA6J51A	SMA6J51CA	MZ	CZ	56.70	62.70	1	1.0	51.0	7.28	82.4
SMA6J54A	SMA6J54CA	NE	DE	60.00	66.30	1	1.0	54.0	6.89	87.1
SMA6J58A	SMA6J58CA	NG	DG	64.40	71.20	1	1.0	58.0	6.41	93.6

Note:

1. Suffix 'A' denotes 5% tolerance device. Without 'A' denotes 10% tolerance device
2. Add suffix 'C' or 'CA' after part number to specify Bi-directional devices
3. For Bi-Directional devices having V_R of 10 volts and under, the I_R limit is double



Ratings and Characteristics Curves ($T_A=25^\circ\text{C}$ unless otherwise noted)

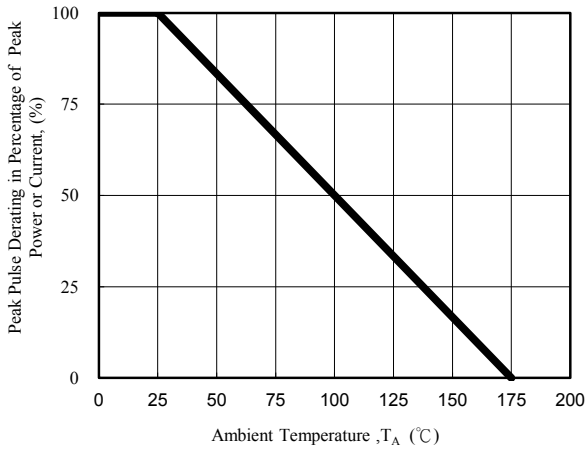

Fig. 1 - Pulse Derating Curve

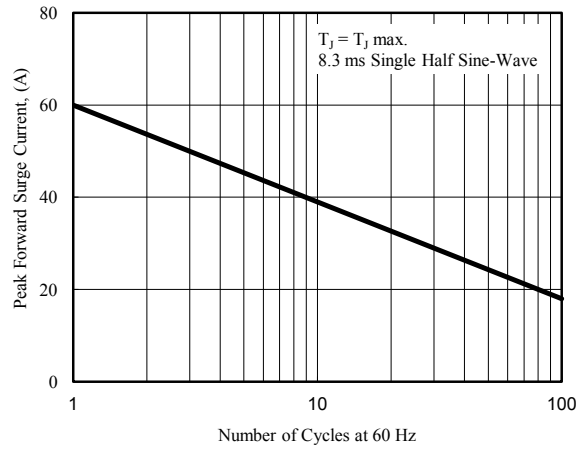

Fig. 2 - Maximum Non-Repetitive Surge Current

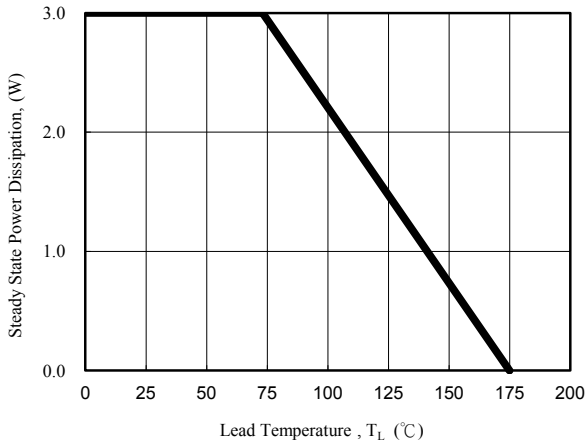

Fig. 3 - Steady State Power Derating Curve

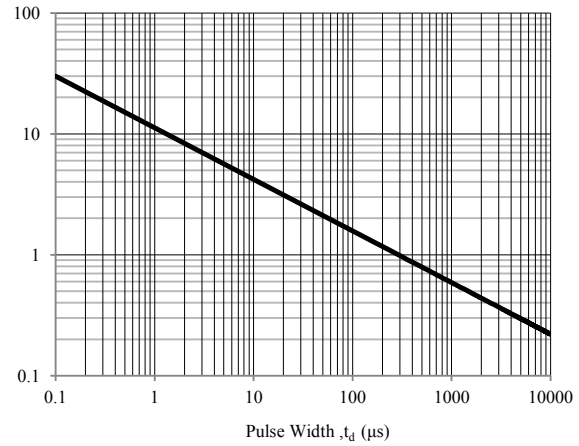

Fig. 4 - Peak Pulse Power Rating Curve

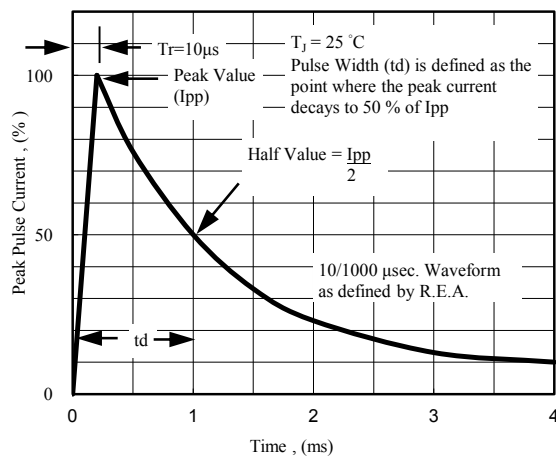

Fig. 5 - Pulse Waveform

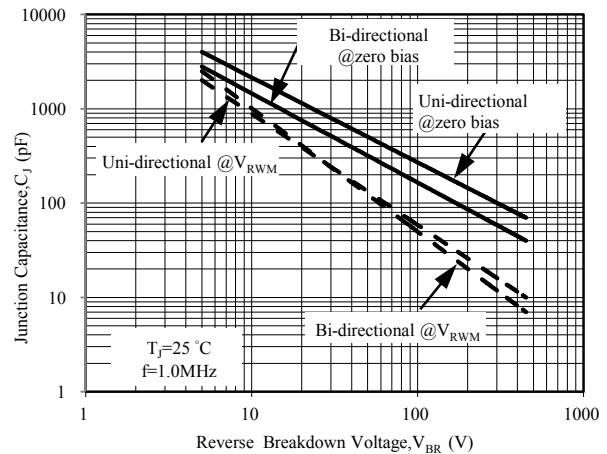

Fig. 6 - Typical Junction Capacitance

PACKAGE	SPQ/PCS	CARTON SPQ/PCS	CARTON SIZE/CM	CARTON GW/KG	CARTON NW/KG
SMA	5000/REEL	80000	36X30.6X31	12.00	11.00