



Reverse Voltage: 28 to 320 V

Peak Pulse Power: 30000 W

Features

- Glass passivated chip
- 30000 W peak pulse power capability with a 10/1000 μ s waveform, repetitive rate (duty cycle):0.01 %
- Low leakage
- Uni and Bidirectional unit
- Excellent clamping capability
- Very fast response time
- RoHS compliant

Mechanical Data

- Case: Molded plastic
- Epoxy: UL 94V-0 rate flame retardant
- Lead: Solderable per MIL-STD-202, method 208 guaranteed
- Polarity: Color band denotes cathode end except Bipolar
- Mounting position: Any

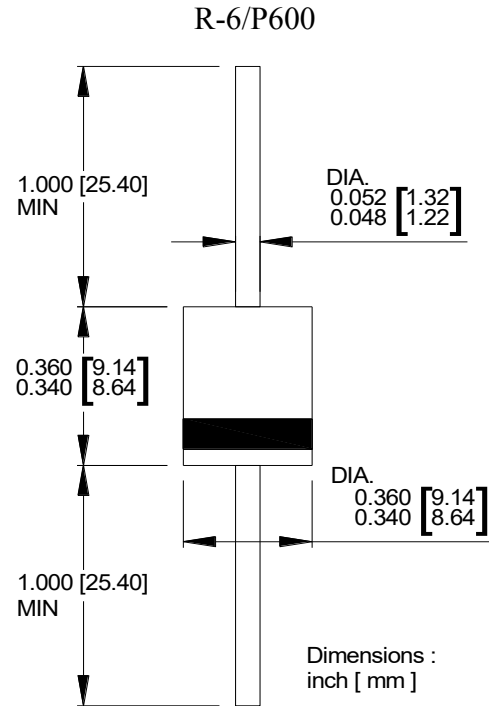

Maximum Ratings($T_A=25^{\circ}\text{C}$ unless otherwise noted)

Parameter	Symbol	Value	Unit
Peak power dissipation with a 10/1000 μ s waveform ⁽¹⁾	P_{PP}	30000	W
Peak pulse current with a 10/1000 μ s waveform ⁽¹⁾	I_{PP}	See Next Table	A
Power dissipation on infinite heatsink at $T_L = 75^{\circ}\text{C}$	P_D	8.0	W
Peak forward surge current, 8.3 ms single half sine-wave unidirectional only ⁽²⁾	I_{FSM}	500	A
Operating junction and storage temperature range	T_J, T_{STG}	- 55 to +175	$^{\circ}\text{C}$

Note:

(1)Non-repetitive current pulse per Fig.5 and derated above $T_A = 25^{\circ}\text{C}$ per Fig.1

(2)Measured on 8.3 ms single half sine-wave or equivalent square wave, duty cycle = 4 pulses per minute maximum



Electrical Characteristics ($T_A=25^\circ\text{C}$ unless otherwise noted)

Part Number (Uni)	Part Number (Bi)	Breakdown Voltage V_{BR} @ I_T			Maximum Reverse Leakage I_R @ V_{RWM} (uA)	Working Peak Reverse Voltage V_{RWM} (V)	Maximum Reverse Surge Current I_{PP} (A)	Maximum Clamping Voltage V_C @ I_{PP} (V)
		Min (V)	Max(V)	I_T (mA)				
30KPA28A	30KPA28CA	31.28	34.41	50	5000	28	606.0	50.0
30KPA30A	30KPA30CA	33.51	36.86	50	5000	30	548.9	55.2
30KPA33A	30KPA33CA	36.90	40.59	50	5000	33	517.9	58.5
30KPA36A	30KPA36CA	40.20	44.22	50	5000	36	490.3	61.8
30KPA39A	30KPA39CA	43.60	47.96	20	2000	39	450.9	67.2
30KPA42A	30KPA42CA	46.90	51.59	10	1000	42	420.8	72.0
30KPA43A	30KPA43CA	48.00	52.80	10	1000	43	415.1	73.0
30KPA45A	30KPA45CA	50.30	55.33	5	250	45	391.5	77.4
30KPA48A	30KPA48CA	53.60	58.96	5	150	48	371.3	81.6
30KPA51A	30KPA51CA	57.00	62.70	5	50	51	350.7	86.4
30KPA54A	30KPA54CA	60.30	66.33	5	20	54	331.5	91.4
30KPA58A	30KPA58CA	64.80	71.28	5	20	58	327.9	92.4
30KPA60A	30KPA60CA	67.00	73.70	5	15	60	297.1	102.0
30KPA64A	30KPA64CA	71.50	78.65	5	10	64	291.3	104.0
30KPA66A	30KPA66CA	73.70	81.07	5	2	66	283.2	107.0
30KPA70A	30KPA70CA	78.20	86.02	5	2	70	278.0	109.0
30KPA71A	30KPA71CA	79.30	87.23	5	2	71	271.7	111.5
30KPA72A	30KPA72CA	80.40	88.44	5	2	72	265.8	114.0
30KPA75A	30KPA75CA	83.80	92.18	5	2	75	253.8	119.4
30KPA78A	30KPA78CA	87.10	95.81	5	2	78	234.9	129.0
30KPA84A	30KPA84CA	93.80	103.18	5	2	84	217.7	139.2
30KPA90A	30KPA90CA	100.50	110.55	5	2	90	207.0	146.4
30KPA96A	30KPA96CA	107.20	117.92	5	2	96	194.2	156.0
30KPA102A	30KPA102CA	113.90	125.29	5	2	102	183.0	165.6
30KPA108A	30KPA108CA	120.60	132.66	5	2	108	172.9	175.2
30KPA120A	30KPA120CA	134.00	147.40	5	2	120	155.9	194.4
30KPA132A	30KPA132CA	147.40	162.14	5	2	132	142.3	213.0
30KPA144A	30KPA144CA	160.80	176.88	5	2	144	135.8	223.2
30KPA150A	30KPA150CA	167.60	184.36	5	2	150	129.8	233.4
30KPA156A	30KPA156CA	174.30	191.73	5	2	156	123.7	245.0
30KPA160A	30KPA160CA	178.70	196.57	5	2	160	120.0	252.6
30KPA168A	30KPA168CA	187.70	206.47	5	2	168	111.2	272.4
30KPA170A	30KPA170CA	189.90	208.89	5	2	170	110.2	275.0
30KPA180A	30KPA180CA	201.10	221.21	5	2	180	104.3	290.4
30KPA198A	30KPA198CA	221.20	243.32	5	2	198	94.7	319.8
30KPA216A	30KPA216CA	241.30	265.43	5	2	216	86.9	348.6
30KPA240A	30KPA240CA	268.10	294.91	5	2	240	78.3	387.0
30KPA258A	30KPA258CA	288.20	317.02	5	2	258	72.8	416.4
30KPA260A	30KPA260CA	290.40	319.44	5	2	260	72.8	416.0
30KPA270A	30KPA270CA	301.60	331.76	5	2	270	69.5	436.2
30KPA280A	30KPA280CA	312.80	344.08	5	2	280	65.3	464.0
30KPA288A	30KPA288CA	321.70	353.87	5	2	288	64.5	469.9
30KPA300A	30KPA300CA	334.00	367.40	5	2	300	62.0	484.0
30KPA320A	30KPA320CA	356.00	392.00	5	2	320	57.0	530.0

Note:

1. For Bi-Directional devices having V_R of 60 volts and under, the I_R limit is double

Ratings and Characteristics Curves ($T_A=25^{\circ}\text{C}$ unless otherwise noted)

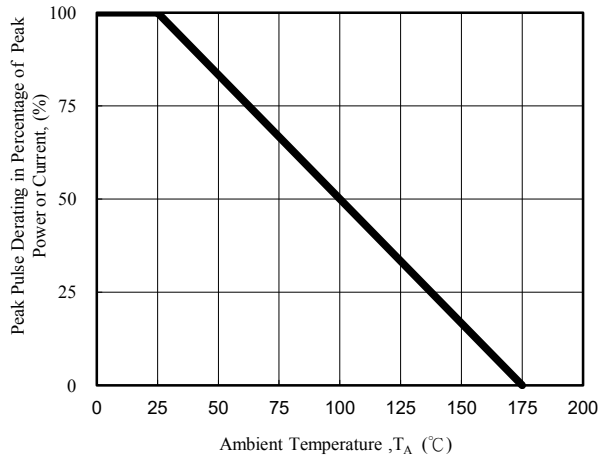

Fig. 1 - Pulse Derating Curve

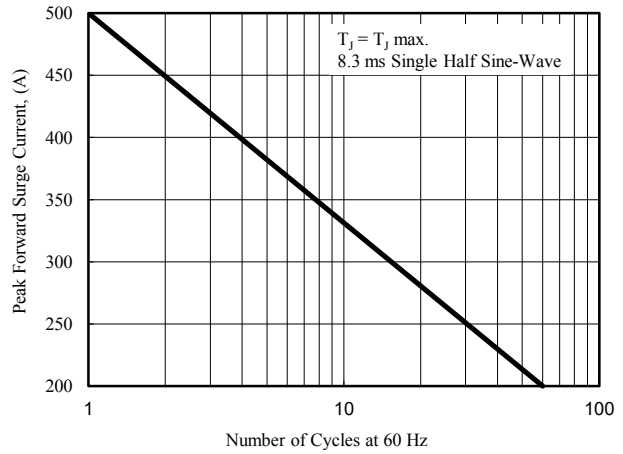

Fig. 2 - Maximum Non-Repetitive Surge Current

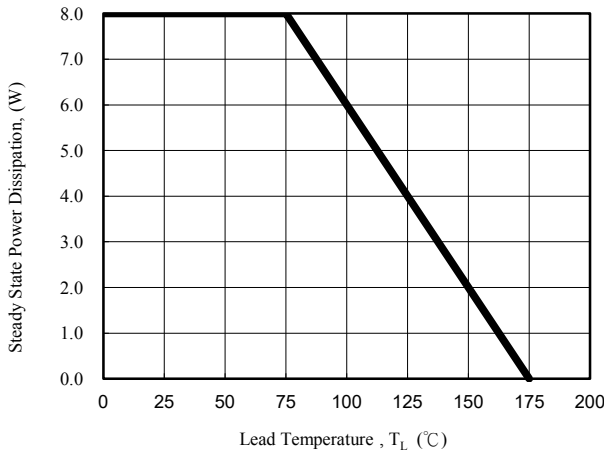

Fig. 3 - Steady State Power Derating Curve

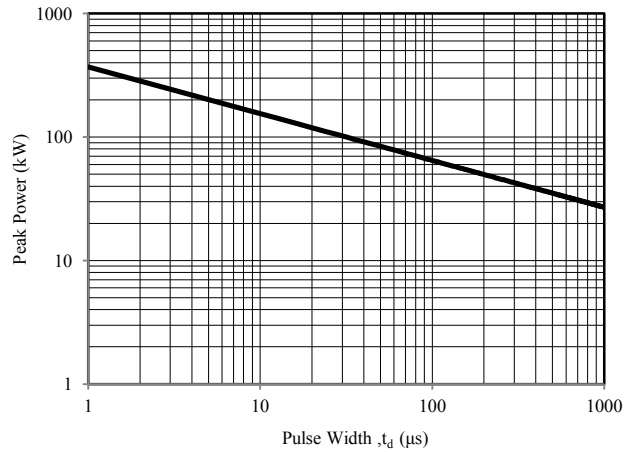

Fig. 4 - Peak Pulse Power Rating Curve

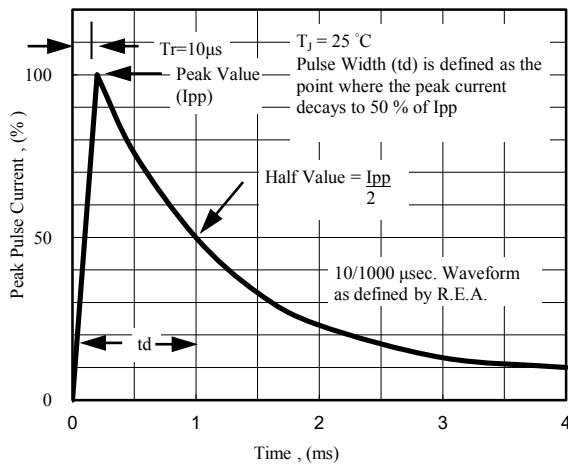

Fig. 5 - Pulse Waveform

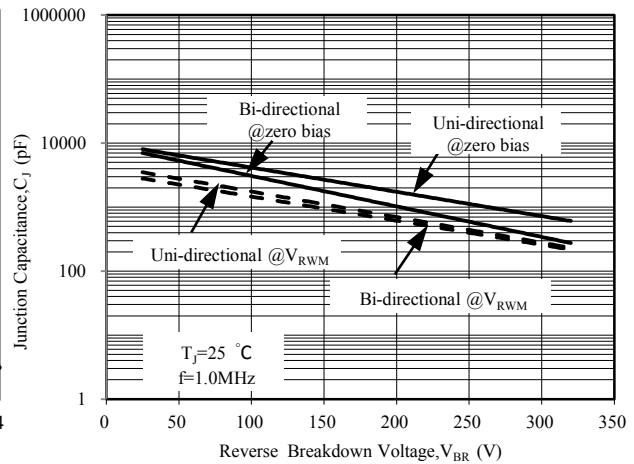

Fig. 6 - Typical Junction Capacitance

PACKAGE	SPQ/PCS	CARTON SPQ/PCS	CARTON SIZE/CM	CARTON GW/KG	CARTON NW/KG
R-6	500/AMMO	5000	44X28X31	12.00	10.00