

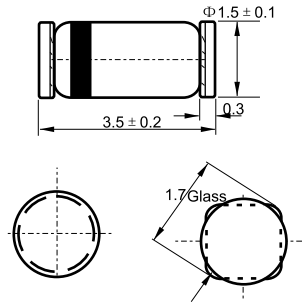

Features

- ✧ Zener voltage range 2.0 to 75 volts
- ✧ LL-34(Mini-MELF) package
- ✧ Surface device type mounting
- ✧ Hermetically sealed glass
- ✧ Compression Bonded Construction
- ✧ All external surfaces are corrosion resistant and terminals are readily solderable
- ✧ RoHS compliant
- ✧ Matte Tin(Sn) lead finish
- ✧ Blue color band indicates negative polarity

MINI-MELF



Dimension in millimeters

Maximum Ratings and Electrical Characteristics

Rating at 25 °C ambient temperature unless otherwise specified.

Type Number	Symbol	Value	Units
Power Dissipation	P _{tot}	500	mW
Operating and Storage Temperature Range	T _J , T _{STG}	-65 to + 200	°C

Notes: These ratings are limiting values above which the serviceability of the diode may be impaired



ELECTRICAL SPECIFICATIONS (T_A = 25°C unless otherwise noted)

PART NUMBER	ZENER VOLTAGE			TEST CURRENT	REGULAR IMPEDANCE		TEST CURRENT	LEAKAGE CURRENT	
	V _Z @ I _{ZT}			I _{ZT}	Z _{ZT} @ I _{ZT}	Z _{ZK} @ I _{ZK}	I _{ZK}	I _R @ V _R	
	V			mA	Ω	Ω	mA	μA	V
	Min	Nom	Max		Max	Max		Max	
BZV55B2V0	1.96	2.0	2.04	5	100	600	1.0	50	1.0
BZV55B2V4	2.35	2.40	2.45	5	85	600	1.0	50	1.0
BZV55B2V7	2.65	2.70	2.75	5	85	600	1.0	10	1.0
BZV55B3V0	2.94	3.00	3.06	5	85	600	1.0	4	1.0
BZV55B3V3	3.23	3.30	3.37	5	85	600	1.0	2	1.0
BZV55B3V6	3.53	3.60	3.67	5	85	600	1.0	2	1.0
BZV55B3V9	3.82	3.90	3.98	5	85	600	1.0	2	1.0
BZV55B4V3	4.21	4.30	4.39	5	75	600	1.0	1	1.0
BZV55B4V7	4.61	4.70	4.79	5	60	600	1.0	0.5	1.0
BZV55B5V1	5.00	5.10	5.20	5	35	550	1.0	0.1	1.0
BZV55B5V6	5.49	5.60	5.71	5	25	450	1.0	0.1	1.0
BZV55B6V2	6.08	6.20	6.32	5	10	200	1.0	0.1	2.0
BZV55B6V8	6.66	6.80	6.94	5	8	150	1.0	0.1	3.0
BZV55B7V5	7.35	7.50	7.65	5	7	50	1.0	0.1	5.0
BZV55B8V2	8.04	8.20	8.36	5	7	50	1.0	0.1	6.2
BZV55B9V1	8.92	9.10	9.28	5	10	50	1.0	0.1	6.8
BZV55B10	9.80	10.0	10.20	5	15	70	1.0	0.1	7.5
BZV55B11	10.78	11.0	11.22	5	20	70	1.0	0.1	8.2
BZV55B12	11.76	12.0	12.24	5	20	90	1.0	0.1	9.1
BZV55B13	12.74	13.0	13.26	5	26	110	1.0	0.1	10
BZV55B15	14.70	15.0	15.30	5	30	110	1.0	0.1	11
BZV55B16	15.68	16.0	16.32	5	40	170	1.0	0.1	12
BZV55B18	17.64	18.0	18.36	5	50	170	1.0	0.1	13
BZV55B20	19.60	20.0	20.40	5	55	220	1.0	0.1	15
BZV55B22	21.56	22.0	22.44	5	55	220	1.0	0.1	16
BZV55B24	23.52	24.0	24.48	5	80	220	1.0	0.1	18
BZV55B27	26.46	27.0	27.54	5	80	220	1.0	0.1	20
BZV55B30	29.40	30.0	30.60	5	80	220	1.0	0.1	22
BZV55B33	32.34	33.0	33.66	5	80	220	1.0	0.1	24
BZV55B36	35.28	36.0	36.72	5	80	220	1.0	0.1	27
BZV55B39	38.22	39.0	39.78	2.5	90	500	0.5	0.1	28
BZV55B43	42.14	43.0	43.86	2.5	90	600	0.5	0.1	32
BZV55B47	46.06	47.0	47.94	2.5	110	700	0.5	0.1	35
BZV55B51	49.98	51.0	52.02	2.5	125	700	0.5	0.1	38
BZV55B56	54.88	56.0	57.12	2.5	135	1000	0.5	0.1	42
BZV55B62	60.76	62.0	63.24	2.5	150	1000	0.5	0.1	47
BZV55B68	66.64	68.0	69.36	2.5	160	1000	0.5	0.1	51
BZV55B75	73.50	75.0	76.50	2.5	170	1000	0.5	0.1	56

Notes:

1. The Zener voltage (V_Z) is tested under pulse condition of 30ms.
2. The device numbers listed have a standard tolerance on the nominal Zener voltage of ±2%.
3. For detailed information on price, availability and delivery of nominal Zener voltages between the voltages shown and tighter voltage tolerances, contact your nearest Taiwan Semiconductor representative.
4. The Zener impedance is derived from the 60-cycle AC voltage, which results when an AC current having an R_{MS} value equal to 10% of the DC Zener current(I_{ZT} or I_{ZK}) is superimposed to I_{ZT} or I_{ZK}.

RATINGS AND CHARACTERISTIC CURVES (BZV55C SERIES)

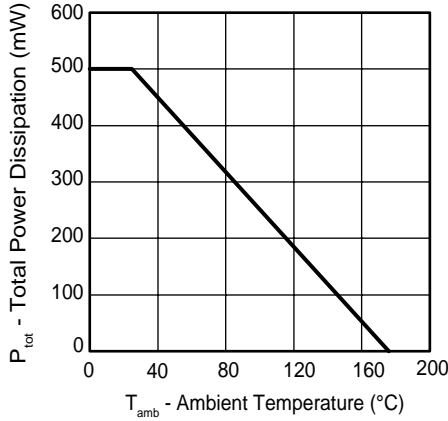

Figure 1. Total Power Dissipation vs. Ambient Temperature

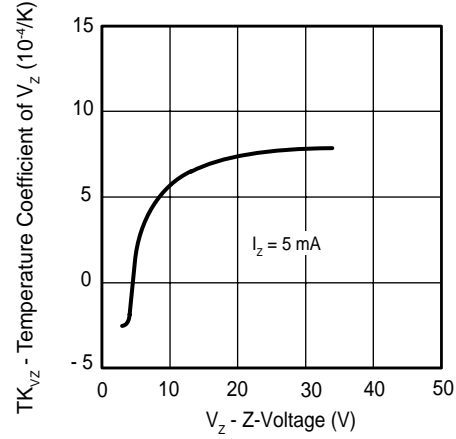

Figure 4. Temperature Coefficient of Vz vs. Z-Voltage

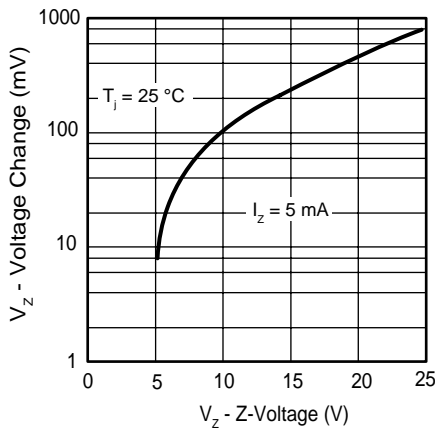

Figure 2. Typical Change of Working Voltage under Operating Conditions at $T_{amb}=25^{\circ}\text{C}$

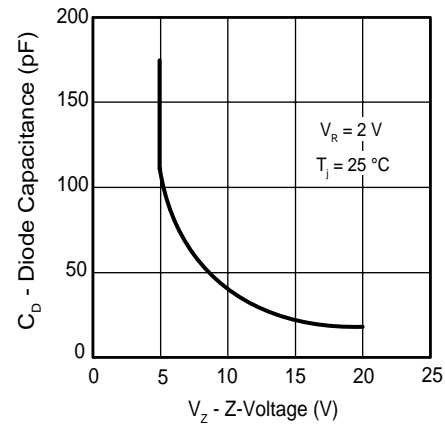

Figure 5. Diode Capacitance vs. Z-Voltage

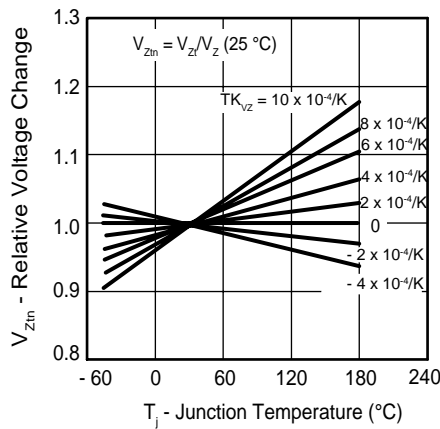

Figure 3. Typical Change of Working Voltage vs. Junction Temperature

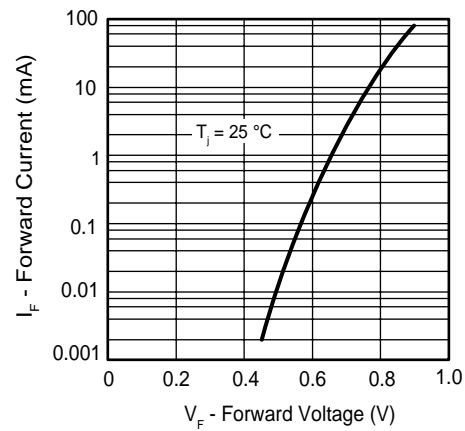

Figure 6. Forward Current vs. Forward Voltage



RATINGS AND CHARACTERISTIC CURVES (BZV55C SERIES)

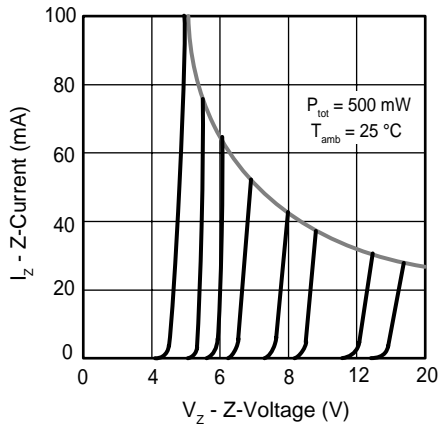

Figure 7. Z-Current vs. Z-Voltage

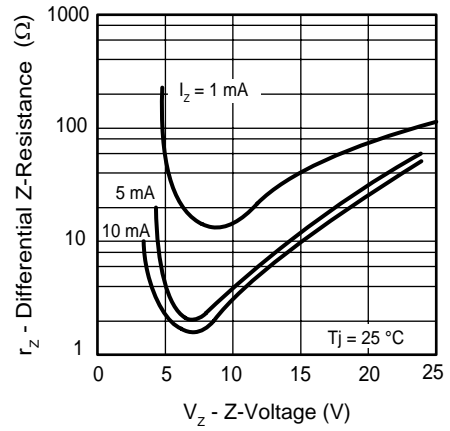

Figure 9. Differential Z-Resistance vs. Z-Voltage

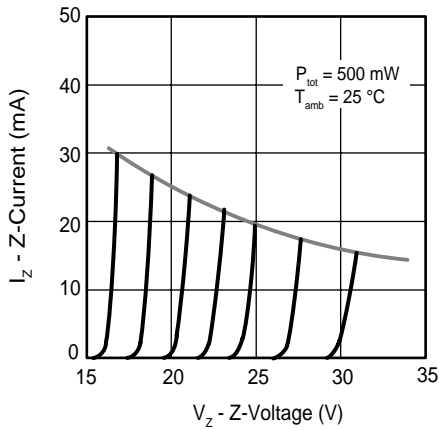

Figure 8. Z-Current vs. Z-Voltage

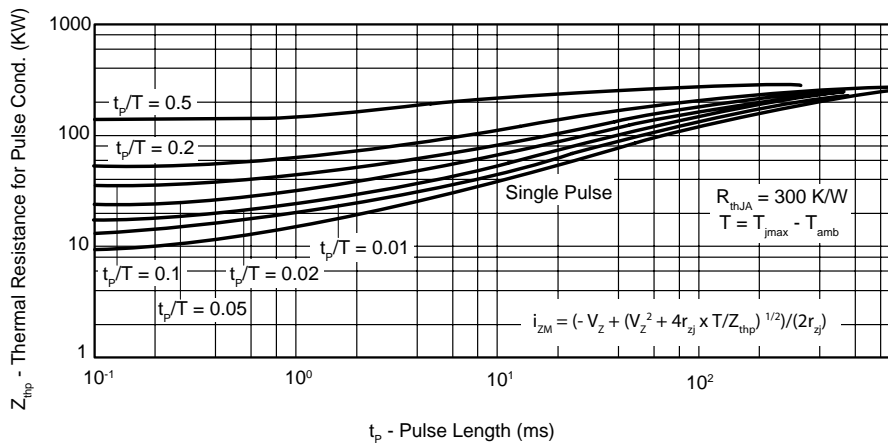

Figure 10. Thermal Response