

1. BASE
2. COLLECTOR
3. EMITTER

SOT-223

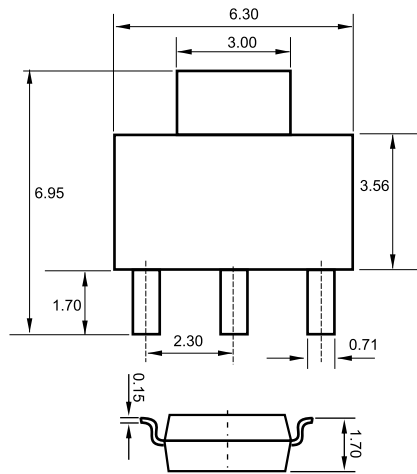

Dimensions in inches and (millimeters)

Features

- ✧ For AF driver and output stages
- ✧ High collector current
- ✧ Low collector-emitter saturation voltage
- ✧ Complementary types: BCP51 ... BCP53 (PNP)

MAXIMUM RATINGS ($T_A=25^\circ\text{C}$ unless otherwise noted)

Symbol	Parameter	BCP54	BCP55	BCP56	Units
V_{CBO}	Collector-Base Voltage	45	60	100	V
V_{CEO}	Collector-Emitter Voltage	45	60	80	V
V_{EBO}	Emitter-Base Voltage	5			V
I_C	Collector Current -Continuous	1			A
P_C	Collector Power Dissipation	1.5			W
$R_{\theta JA}$	Thermal Resistance Junction to Ambient	94			$^\circ\text{C/W}$
T_{stg}	Storage Temperature Range	-65to+150			$^\circ\text{C}$

ELECTRICAL CHARACTERISTICS ($T_{amb}=25^\circ\text{C}$ unless otherwise specified)

Parameter	Symbol	Test conditions	MIN	MAX	UNIT
Collector-base breakdown voltage	BCP54	$I_C = 0.1\text{mA}, I_E = 0$	45		V
	BCP55		60		
	BCP56		100		
Collector-emitter breakdown voltage	BCP54	$I_C = 10\text{mA}, I_B = 0$	45		V
	BCP55		60		
	BCP56		80		
Base-emitter breakdown voltage	$V_{(BR)EBO}$	$I_C = 10\mu\text{A}, I_E = 0$	5		V
Collector cut-off current	I_{CBO}	$V_{CB} = 30\text{V}, I_E = 0$		100	nA
DC current gain	$h_{FE(1)}$	$V_{CE} = 2\text{V}, I_C = 5\text{mA}$	25		
	$h_{FE(2)}$	$V_{CE} = 2\text{V}, I_C = 150\text{mA}$	63	250	
	$h_{FE(3)}$	$V_{CE} = 2\text{V}, I_C = 500\text{mA}$	25		
Collector-emitter saturation voltage	$V_{CE(sat)}$	$I_C = 500\text{mA}, I_B = 50\text{mA}$		0.5	V
Base-emitter voltage	V_{BE}	$V_{CE} = 2\text{V}, I_C = 500\text{mA}$		1	V
Transition frequency	f_T	$V_{CE} = 10\text{V}, I_C = 50\text{mA}, f = 100\text{MHz}$	100		MHz

CLASSIFICATION OF $h_{FE(2)}$

Rank	BCP54-10, BCP55-10, BCP56-10	BCP54-16, BCP55-16, BCP56-16
Range	63-160	100-250



Typical Characteristics

Total power dissipation $P_{tot} = f(T_S)$

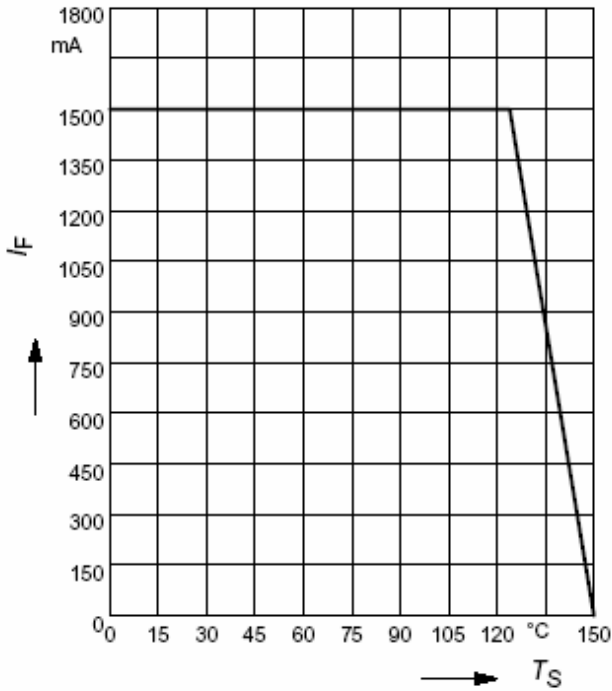

Transition frequency $f_T = f(I_C)$

$V_{CE} = 10V$

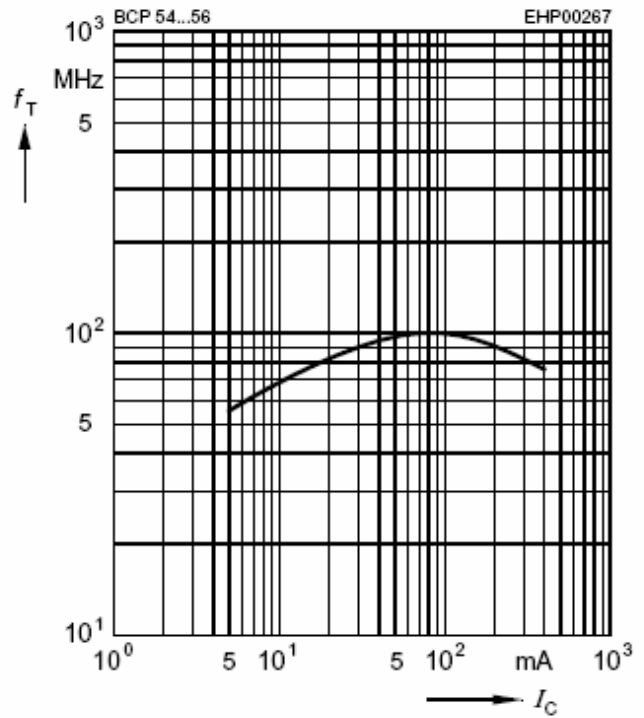

DC current gain $h_{FE} = f(I_C)$

$V_{CE} = 2V$

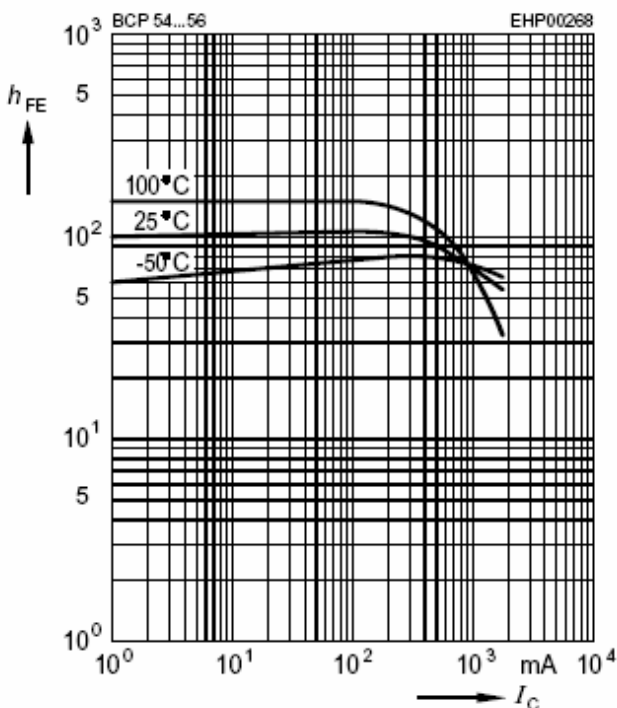

Collector cutoff current $I_{CBO} = f(T_A)$

$V_{CB} = 30V$

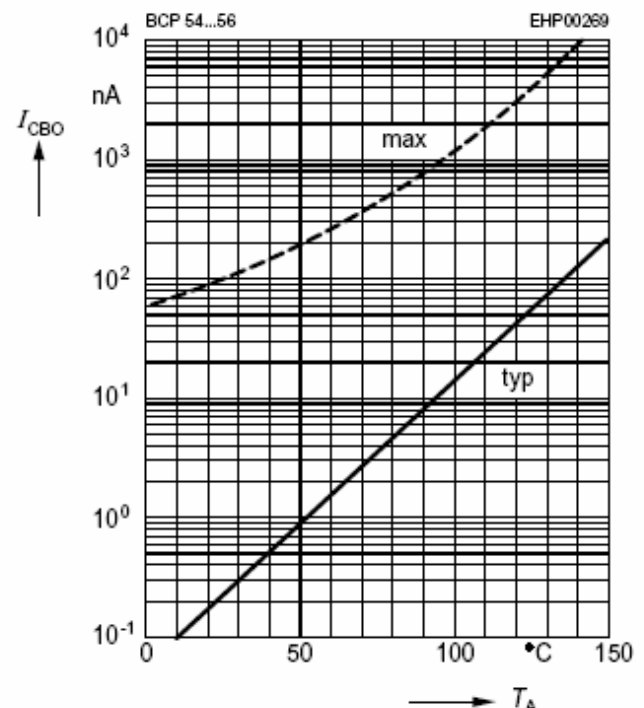



Base-emitter saturation voltage

$$I_C = f(V_{BEsat}), h_{FE} = 10$$

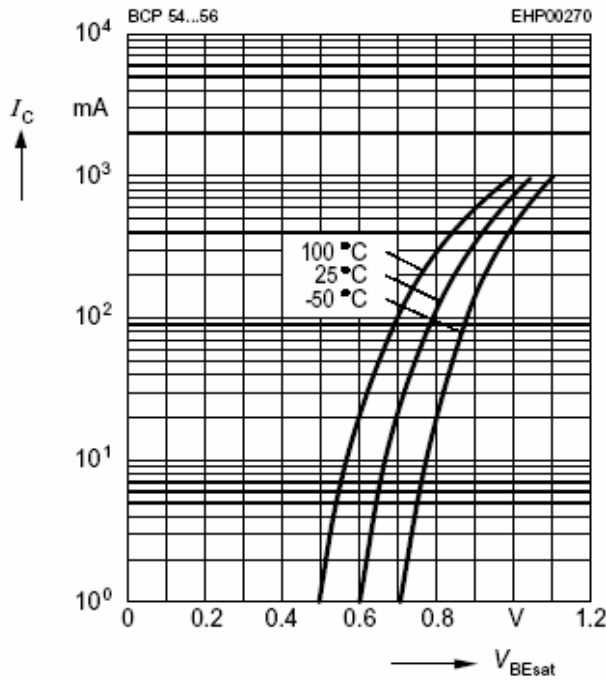

Collector-emitter saturation voltage

$$I_C = f(V_{CEsat}), h_{FE} = 10$$

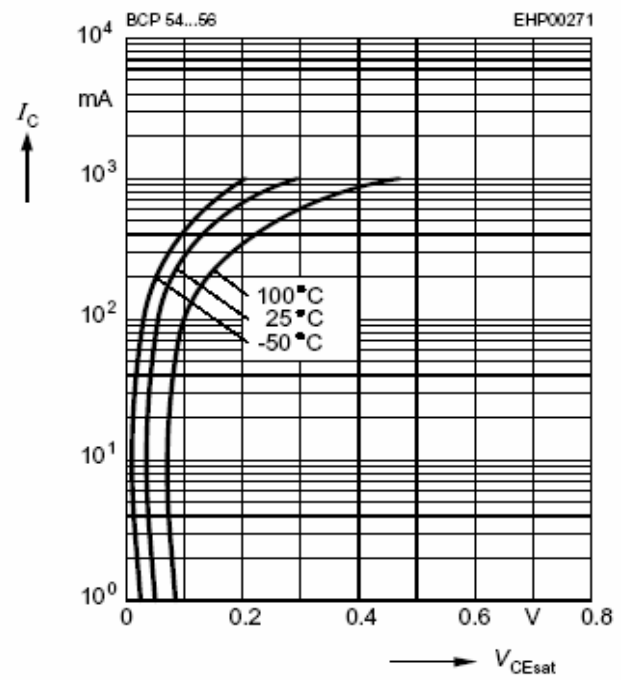

Permissible pulse load

$$P_{totmax} / P_{totDC} = f(t_p)$$

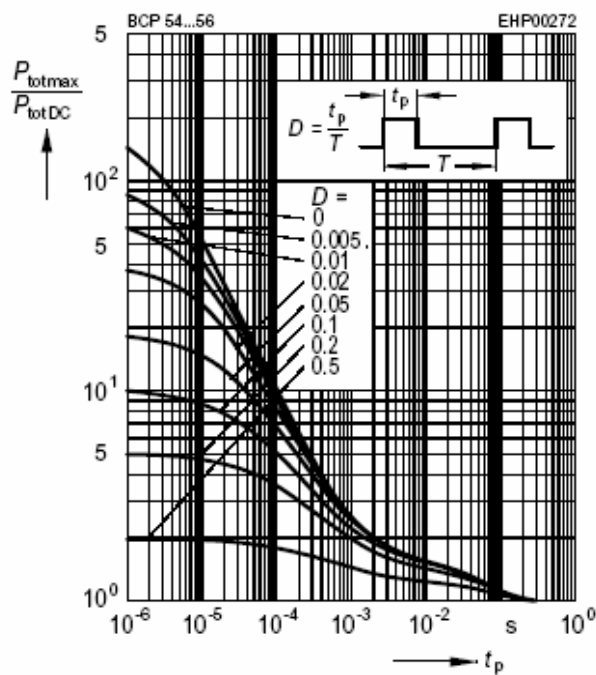

Package	Reel	Reel Size	Box	Box Size(mm)	Carton	Carton Size(mm)
SOT -223	2500pcs	13inch	2500pcs	336x336x48	20,000pcs	445x355x365