



### Features

- Adopt FRD chip
- Low forward Voltage drop
- Fast reverse recovery time
- High frequency operation
- High purity, high temperature epoxy encapsulation for enhanced mechanical strength and moisture resistance
- Guard ring for enhanced ruggedness and long term reliability

### Typical Applications

Typical applications are in switching power supplies, converters, freewheeling diodes, and reverse battery protection.

### Mechanical Data

- **Package:** TO-220AC ITO-220AC  
Molding compound meets UL 94 V-0 flammability rating, RoHS-compliant
- **Terminals:** Tin plated leads, solderable per J-STD-002 and JESD22-B102
- **Polarity:** As marked

### Maximum Ratings (Ta=25°C Unless otherwise specified)

TYPE	V <sub>RSM</sub> V	V <sub>R</sub> RM V
MUR1620	200	200
MUR1620F	200	200

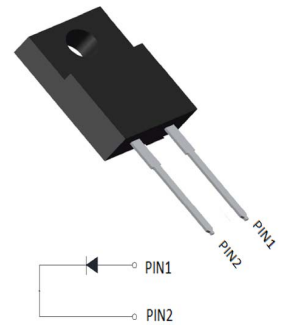
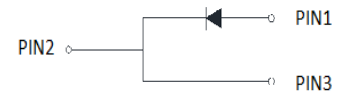
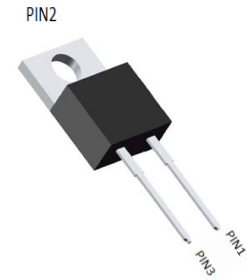

Symbol	Test Conditions	Maximum Ratings	Unit	
I <sub>FRMS</sub>	T <sub>VJ</sub> =T <sub>VJM</sub>	25	A	
I <sub>FAVM</sub>	T <sub>C</sub> =100°C; rectangular, d=0.5	16		
I <sub>FRM</sub>	t <sub>p</sub> <10us; rep. rating, pulse width limited by T <sub>VJM</sub>	150		
I <sub>FSM</sub>	T <sub>VJ</sub> =45°C	t=10ms (50Hz), sine t=8.3ms (60Hz), sine	150 160	A
	T <sub>VJ</sub> =150°C	t=10ms(50Hz), sine t=8.3ms(60Hz), sine	125 135	
I <sup>2</sup> t	T <sub>VJ</sub> =45°C	t=10ms (50Hz), sine t=8.3ms (60Hz), sine	50 50	A <sup>2</sup> s
	T <sub>VJ</sub> =150°C	t=10ms(50Hz), sine t=8.3ms(60Hz), sine	36 37	
T <sub>VJ</sub>		-40...+175	°C	
T <sub>VJM</sub>		175		
T <sub>stg</sub>		-40...+175		
P <sub>tot</sub>	T <sub>C</sub> =25°C	62	W	
M <sub>d</sub>	Mounting torque	0.4...0.6	Nm	
Weight		2	g	

## ■Electrical Characteristics

Symbol	Test Conditions	Characteristic Values		Unit
		typ.	max.	
I <sub>R</sub>	T <sub>VJ</sub> =25°C; V <sub>R</sub> =V <sub>RRM</sub>		50	uA
	T <sub>VJ</sub> =25°C; V <sub>R</sub> =0.8·V <sub>RRM</sub>		25	uA
	T <sub>VJ</sub> =125°C; V <sub>R</sub> =0.8·V <sub>RRM</sub>		3	mA
V <sub>F</sub>	I <sub>F</sub> =16A; T <sub>VJ</sub> =150°C T <sub>VJ</sub> =25°C		1.05 1.15	V
V <sub>TO</sub>	For power-loss calculations only		1.12	V
r <sub>T</sub>	T <sub>VJ</sub> =T <sub>VJM</sub>		23.2	mΩ
R <sub>thJC</sub> R <sub>thCK</sub> R <sub>thJA</sub>		0.5	2 60	K/W
t <sub>rr</sub>	I <sub>F</sub> =1A; -di/dt=50A/us; V <sub>R</sub> =30V; T <sub>VJ</sub> =25°C	35	50	ns
I <sub>RM</sub>	V <sub>R</sub> =350V; I <sub>F</sub> =15A; -di <sub>F</sub> /dt=100A/us; L≤0.05uH; T <sub>VJ</sub> =100°C	4	4.4	A

## ■Thermal Characteristics (T<sub>a</sub>=25°C Unless otherwise specified)

PARAMETER		SYMBOL	UNIT	MUR1620/MUR1620F
Thermal Resistance	Between junction and case	R <sub>θJ-C</sub>	°C/W	4.0
	Between junction and Air	R <sub>θJ-A</sub>	°C/W	50

## ■Ordering Information (Example)

PREFERRED P/N	UNIT WEIGHT(g)	MINIMUM PACKAGE(pcs)	INNER BOX QUANTITY(pcs)	OUTER CARTON QUANTITY(pcs)	DELIVERY MODE
MUR1620/MUR1620F	Approximate 1.6	50	1000	5000	Tube

## ■Characteristics (Typical)

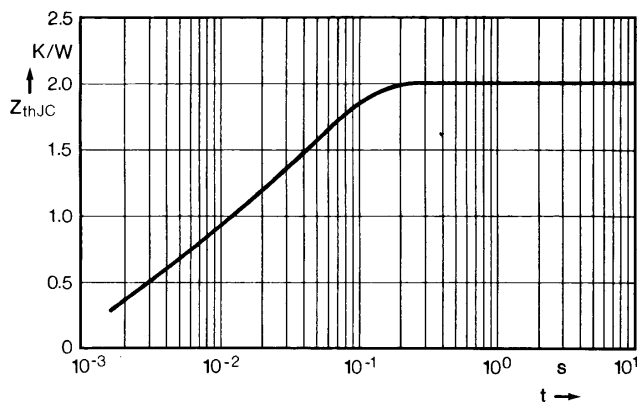

Fig. 7 Transient thermal impedance junction to case.

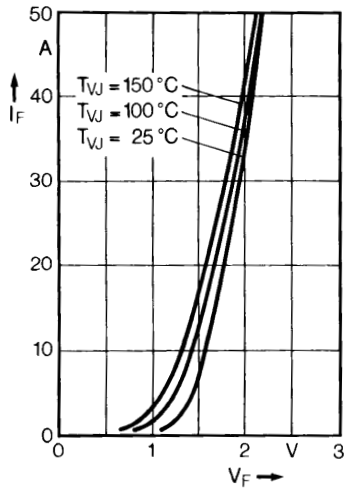

Fig. 1 Forward current versus voltage drop.

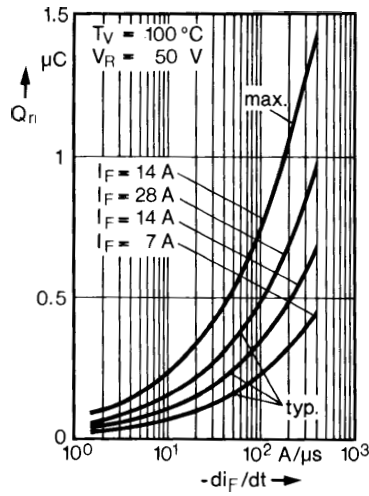

Fig. 2 Recovery charge versus  $-di_F/dt$ .

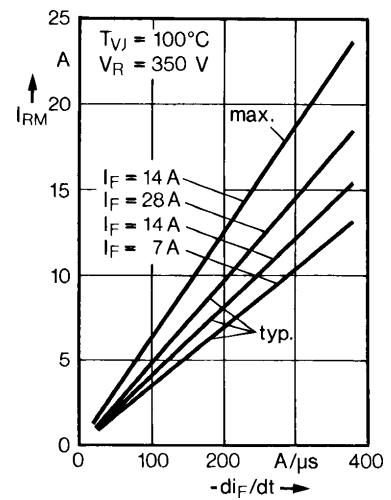

Fig. 3 Peak reverse current versus  $-di_F/dt$ .

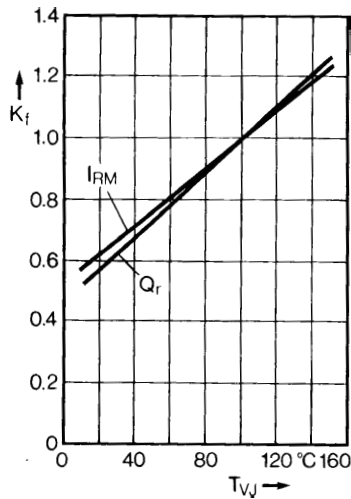

Fig. 4 Dynamic parameters versus junction temperature.

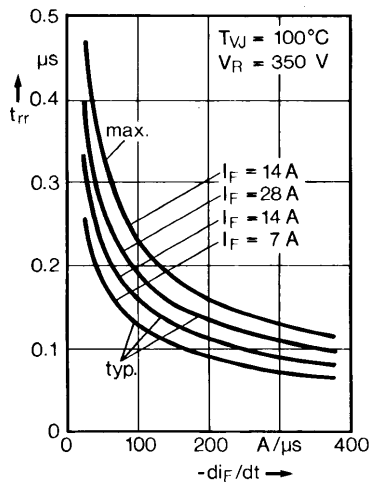

Fig. 5 Recovery time versus  $-di_F/dt$ .

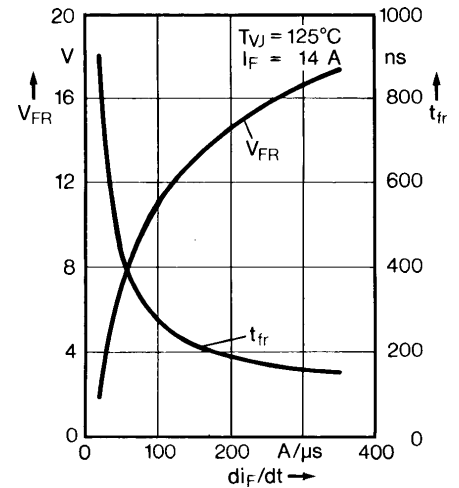
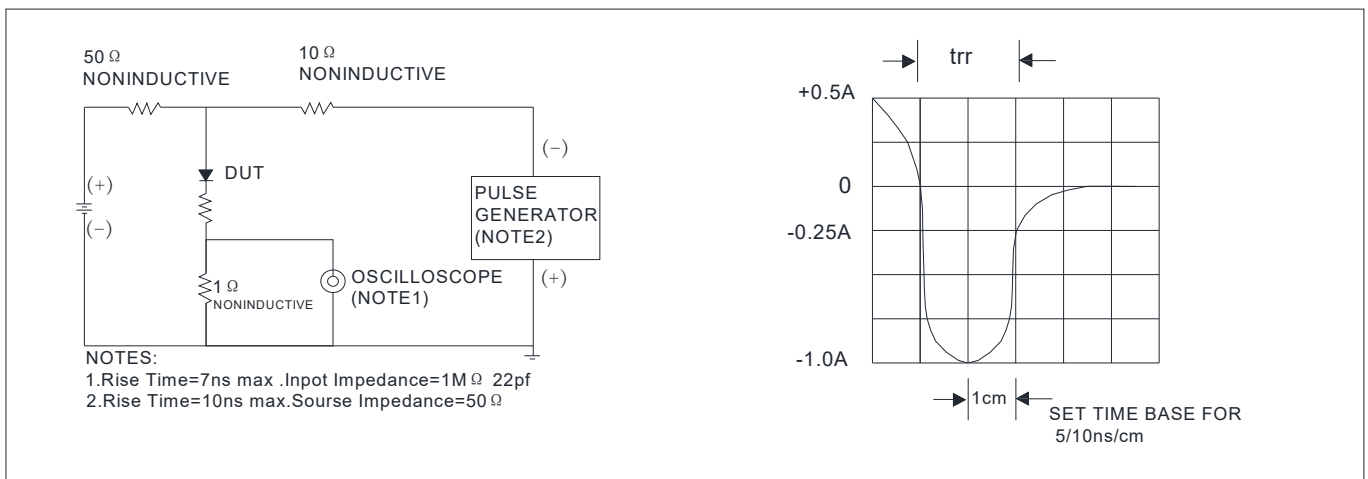
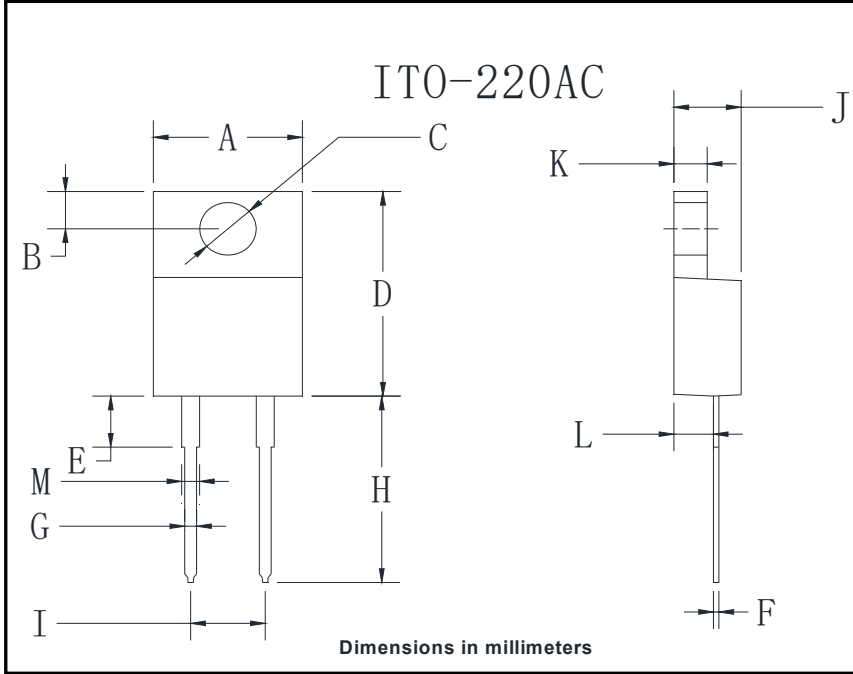

Fig. 6 Peak forward voltage versus  $di_F/dt$ .

FIG.5: Diagram of circuit and Testing wave form of reverse recovery time



## Outline Dimensions



ITO-220AC		
Dim	Min	Max
A	9.8	10.2
B	2.54	3.45
C	2.95	3.45
D	14.23	16.51
E	2.51	3.3
F	0.45	0.75
G	0.65	0.87
H	12.70	14.73
I	4.97	5.23
J	4.3	4.8
K	2.5	2.74
L	1.65	2.30
M	1.03	1.43

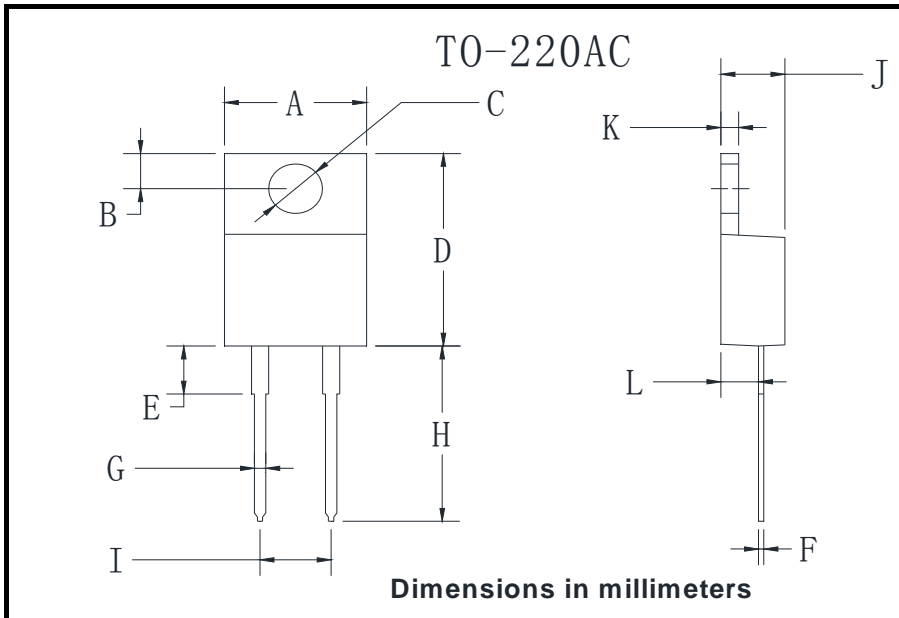

TO-220AC		
Dim	Min	Max
A	9.95	10.35
B	2.55	2.95
C	3.75	4.05
D	14.95	15.25
E	3.75	4.25
F	0.26	0.5
G	0.68	0.94
H	13.3	13.9
I	4.86	5.26
J	4.38	4.78
K	1.14	1.4
L	2.37	2.79

Package	Packing	Box Size L×W×H(mm)	Quantity(pcs/box)	Carton Size L×W×H(mm)	Quantity(pcs/carton)
TO-220AC	50pcs/Tube	558×148×38	1000	565×225×175	5000