



Working Voltage: 10 to 85 V

Peak Pulse Power: 400 W

Features

- Glass passivated chip
- 400 W peak pulse power capability with a 10/1000 μ s waveform, repetitive rate (duty cycle):0.01 %
- High reliability application and automotive grade AEC Q101 qualified
- Low leakage
- Uni and Bidirectional unit ●
- Excellent clamping capability ●
- Very fast response time
- RoHS compliant

Mechanical Data

- Case: Molded plastic
- Epoxy: UL 94V-0 rate flame retardant
- Lead: Solderable per MIL-STD-750, method 2026
- Polarity: Color band denotes cathode end except Bipolar
- Mounting position: Any

SMA/ DO-214AC

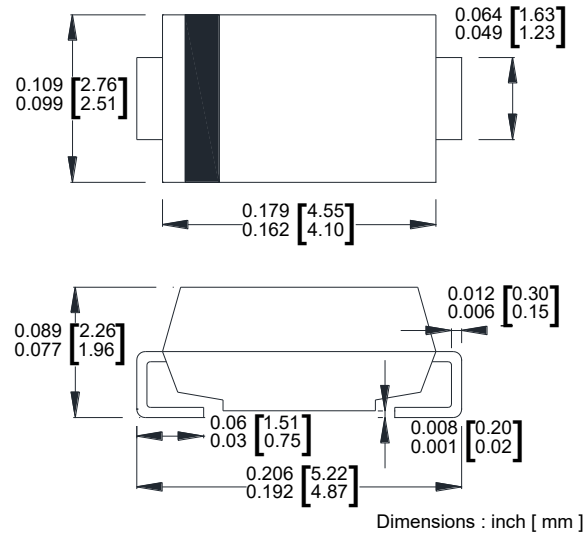

Maximum Ratings($T_A=25^\circ\text{C}$ unless otherwise noted)

Parameter	Symbol	Value	Unit
Peak power dissipation with a 10/1000 μ s waveform ⁽¹⁾	P_{PP}	400	W
Peak pulse current with a 10/1000 μ s waveform ⁽¹⁾	I_{PP}	See Next Table	A
Power dissipation on infinite heatsink at $T_L = 75^\circ\text{C}$	P_D	1.0	W
Peak forward surge current, 8.3 ms single half sine-wave unidirectional only ⁽²⁾	I_{FSM}	40	A
Maximum instantaneous forward voltage at 25 A for unidirectional only ⁽³⁾	V_F	3.5/5.0	V
Operating junction and storage temperature range	T_J, T_{STG}	- 55 to +150	$^\circ\text{C}$

Note:

(1)Non-repetitive current pulse per Fig.5 and derated above $T_A = 25^\circ\text{C}$ per Fig.1

(2)Measured on 8.3 ms single half sine-wave or equivalent square wave, duty cycle = 4 pulses per minute maximum

(3) $V_F < 3.5\text{V}$ for devices of $V_{BR} < 200\text{V}$ and $V_F < 5.0\text{V}$ for devices of $V_{BR} > 201\text{V}$



Electrical Characteristics($T_A=25^{\circ}\text{C}$ unless otherwise noted)

Part Number (Uni)	Part Number (Bi)	Device Marking Code		Breakdown Voltage V_{BR} @ I_T			Maximum Reverse Leakage I_R @ V_{RWM} (uA)	Working Peak Reverse Voltage V_{RWM} (V)	Maximum Reverse Surge Current I_{PP} (A)	Maximum Clamping Voltage V_C @ I_{PP} (V)
		Uni	Bi	Min (V)	Max (V)	I_T (mA)				
TPSMAJ10A	TPSMAJ10CA	AXA	WXA	11.10	12.30	1	5	10.0	23.53	17.0
TPSMAJ11A	TPSMAJ11CA	AZA	WZA	12.20	13.50	1	1	11.0	21.98	18.2
TPSMAJ12A	TPSMAJ12CA	BEA	XEA	13.30	14.70	1	1	12.0	20.10	19.9
TPSMAJ13A	TPSMAJ13CA	BGA	XGA	14.40	15.90	1	1	13.0	18.60	21.5
TPSMAJ14A	TPSMAJ14CA	BKA	XKA	15.60	17.20	1	1	14.0	17.24	23.2
TPSMAJ15A	TPSMAJ15CA	BMA	XMA	16.70	18.50	1	1	15.0	16.39	24.4
TPSMAJ16A	TPSMAJ16CA	BPA	XPA	17.80	19.70	1	1	16.0	15.38	26.0
TPSMAJ17A	TPSMAJ17CA	BRA	XRA	18.90	20.90	1	1	17.0	14.49	27.6
TPSMAJ18A	TPSMAJ18CA	BTA	XTA	20.00	22.10	1	1	18.0	13.70	29.2
TPSMAJ19A	TPSMAJ19CA	BBA	XBA	21.10	23.30	1	1	19.0	13.00	30.8
TPSMAJ20A	TPSMAJ20CA	BVA	XVA	22.20	24.50	1	1	20.0	12.35	32.4
TPSMAJ22A	TPSMAJ22CA	BXA	XXA	24.40	26.90	1	1	22.0	11.27	35.5
TPSMAJ24A	TPSMAJ24CA	BZA	XZA	26.70	29.50	1	1	24.0	10.28	38.9
TPSMAJ26A	TPSMAJ26CA	CEA	YEA	28.90	31.90	1	1	26.0	9.50	42.1
TPSMAJ28A	TPSMAJ28CA	CGA	YGA	31.10	34.40	1	1	28.0	8.81	45.4
TPSMAJ30A	TPSMAJ30CA	CKA	YKA	33.30	36.80	1	1	30.0	8.26	48.4
TPSMAJ33A	TPSMAJ33CA	CMA	YMA	36.70	40.60	1	1	33.0	7.50	53.3
TPSMAJ36A	TPSMAJ36CA	CPA	YPA	40.00	44.20	1	1	36.0	6.88	58.1
TPSMAJ40A	TPSMAJ40CA	CRA	YRA	44.40	49.10	1	1	40.0	6.20	64.5
TPSMAJ43A	TPSMAJ43CA	CTA	YTA	47.80	52.80	1	1	43.0	5.76	69.4
TPSMAJ45A	TPSMAJ45CA	CVA	YVA	50.00	55.30	1	1	45.0	5.50	72.7
TPSMAJ48A	TPSMAJ48CA	CXA	YXA	53.30	58.90	1	1	48.0	5.17	77.4
TPSMAJ51A	TPSMAJ51CA	CZA	YZA	56.70	62.70	1	1	51.0	4.85	82.4
TPSMAJ54A	TPSMAJ54CA	REA	ZEA	60.00	66.30	1	1	54.0	4.59	87.1
TPSMAJ58A	TPSMAJ58CA	RGA	ZGA	64.40	71.20	1	1	58.0	4.27	93.6
TPSMAJ60A	TPSMAJ60CA	RKA	ZKA	66.70	73.70	1	1	60.0	4.13	96.8
TPSMAJ64A	TPSMAJ64CA	RMA	ZMA	71.10	78.60	1	1	64.0	3.88	103.0
TPSMAJ70A	TPSMAJ70CA	RPA	ZPA	77.80	86.00	1	1	70.0	3.54	113.0
TPSMAJ75A	TPSMAJ75CA	RRA	ZRA	83.30	92.10	1	1	75.0	3.31	121.0
TPSMAJ78A	TPSMAJ78CA	RTA	ZTA	86.70	95.80	1	1	78.0	3.17	126.0
TPSMAJ80A	TPSMAJ80CA	RBA	ZBA	88.80	97.60	1	1	80.0	3.09	129.6
TPSMAJ85A	TPSMAJ85CA	RVA	ZVA	94.40	104.00	1	1	85.0	2.92	137.0

Note:

1. Add suffix 'C' or 'CA' after part number to specify Bi-directional devices
2. For Bi-Directional devices having V_R of 10 volts and under, the I_R limit is double



Ratings and Characteristics Curves ($T_A=25^\circ\text{C}$ unless otherwise noted)

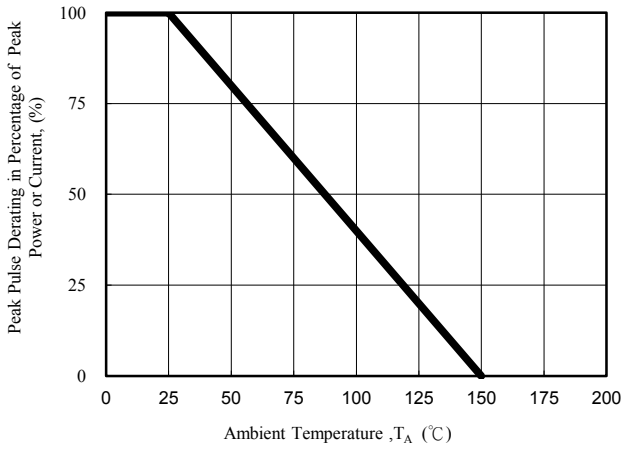

Fig. 1 - Pulse Derating Curve

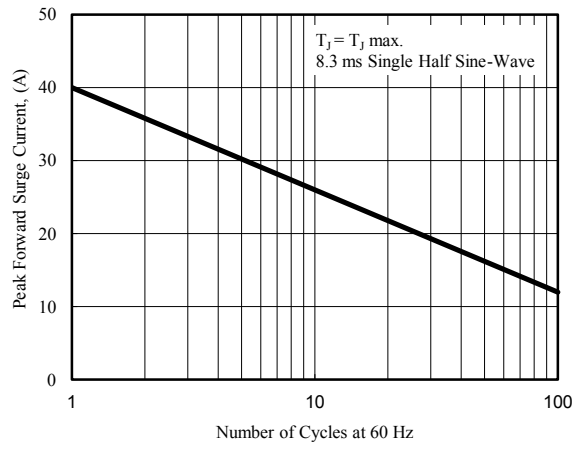

Fig. 2 - Maximum Non-Repetitive Surge Current

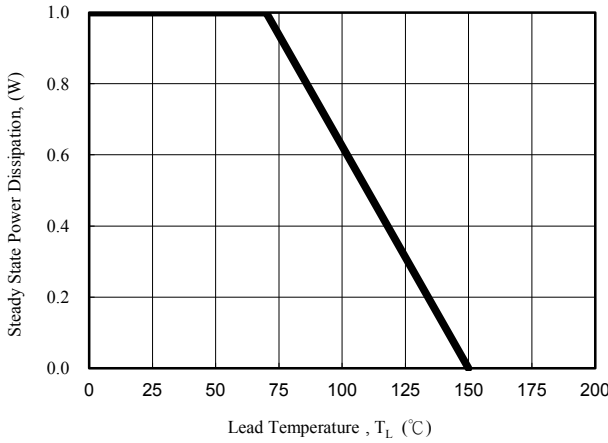

Fig. 3 - Steady State Power Derating Curve

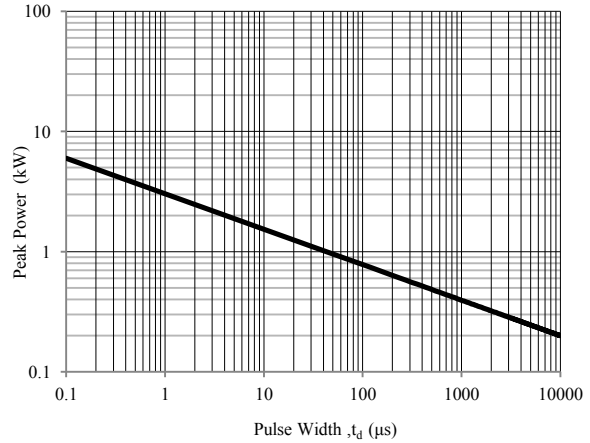

Fig. 4 - Peak Pulse Power Rating Curve

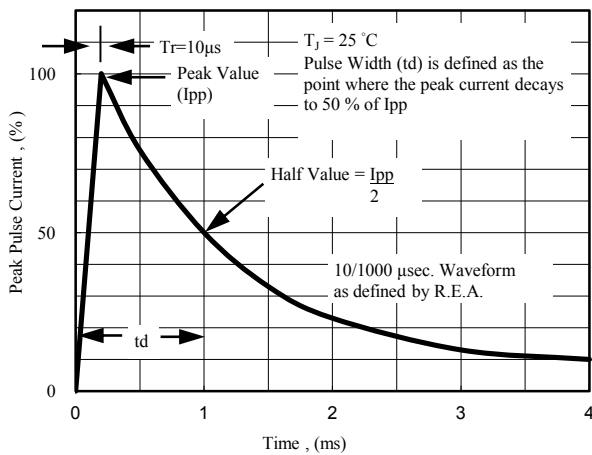

Fig. 5 - Pulse Waveform

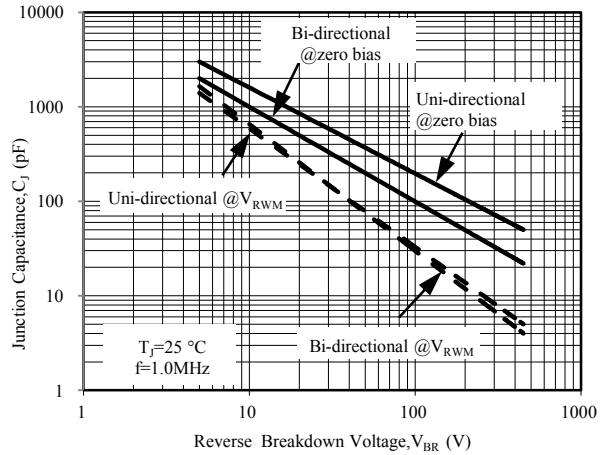

Fig. 6 - Typical Junction Capacitance

PACKAGE	SPQ/PCS	CARTON SPQ/PCS	CARTON SIZE/CM	CARTON GW/KG	CARTON NW/KG
SMA	5000/REEL	80000	36X30.6X31	12.00	11.00